

# Ambrogio Robot L50 EU

Rev. "A"
Rev. "B"
Rev. "C"
Rev. "I"
Rev. "F"

**Rev. "F" - Maggio 2010**  
**Rev. "F" - May 2010**

**Catalogo Parti di Ricambio**  
**Spare Parts Catalogue**

MD-CO-RO-21 - Rev. 1.4 - 27/04/2010



**Suggested Price List. Only for Italy**  
**Delivery cost not included**

**Listino al pubblico**  
**Trasporto non incluso**

**ZUCCHETTI**  
**CENTRO SISTEMI**  
LE SOLUZIONI CHE CREANO SUCCESSO



1



2



3



4

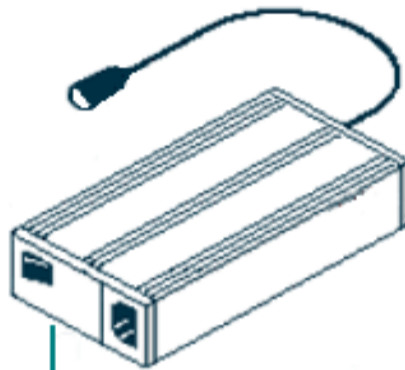

5



6

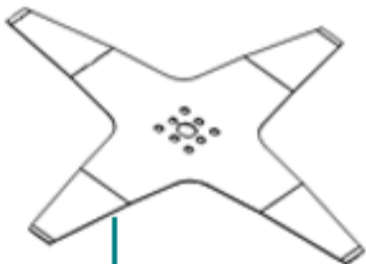

7

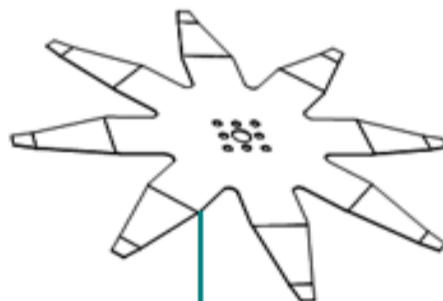

8

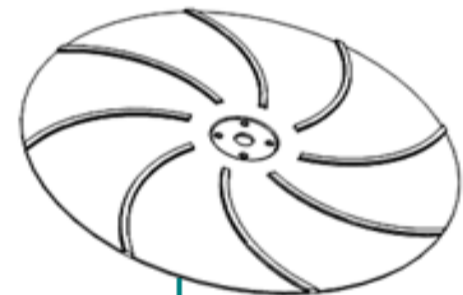

9



10

Tav.  
Tab.  
Taf.

01

0

--

Rif.	Code	Qty. Part.	Sigla	(IT) Descrizione * (GB) Description	Qty. Price
1	50_ML_L50-V10	1		(EU) - Manuale d'uso - User's Manual	1
2	50_D0035_00	1		(EU) - Imballo Robot - Robot Packaging	1
2	50_D0034_00	1		(EU) - Imballo Esterno - External Packaging	1
3	CS_C0109	1	200 Gr	Grasso - Grease	1
4	50_E0011_00	1		Kit Ricarica - Kit for Charging	1
5	50_E0009_00	1	29.3V Lithium	Caricabatteria - Battery Charger	1
6	AMBCAALRE	1		Cavo Alimentazione - Supply Cable	1
7	50_D0018_02	1	4KB Ø24 Cm	Lama piegata a 4 Punte - 4 knives bent blade	1
8	050Z06000A	1	8KB Ø24 Cm	Lama piegata a 8 Punte - 8 knives bent blade	1
9	50_D0056_00	1		Disco Pulente - Cleaning Plate	1
10	AMBCAPROG	1		Programming Cable - Cavo Programmazione	1

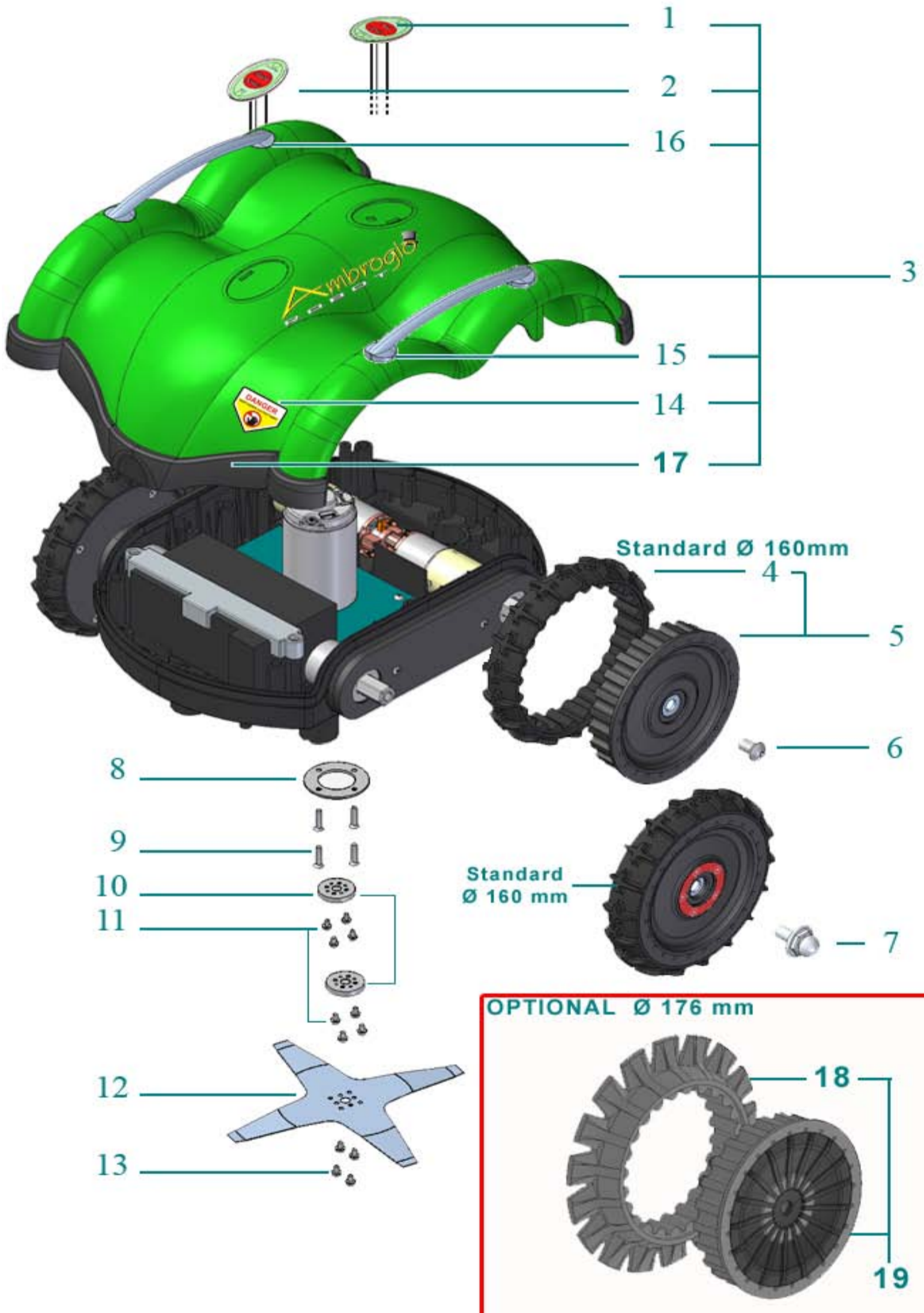

Tav.	02	0	
Tab.			
Taf.			

Rif.	Code	Qty. Part.	Sigla	(IT) Descrizione * (GB) Description	Qty. Price	Net Price	Public Price
1	50_D0002_01	1		Tasto Start/Pause - Start/Pause Key	1		
2	50_D0001_01	1		Tasto On/Off - On/Off Key	1		
3	50_A0014_00	1		Gruppo Calotta - Cap Set	1		
4	50_D0037	4		Ø 160 - Copertone - Tire	1		
5	50_A0009_00	4		Ruota - Wheel	1		
6	C00161	2	M10X16	Vite - Screw	10		
7	50_D0017_00	2		Pomelli Ricarica - Charging Bolt	1		
8	50_D0016_00	1		Supporto Motore - Motor Support	1		
9	C00041	4	M5X12	Vite - Screw	100		
10	50_D0019_00	1		Distanziale - Spacer	1		
11	C00212	4	M4X8	Vite - Screw	100		
12	50_D0018_02	1	4KB Ø24 Cm	Lama piegata a 4 Punte - 4 knives bent blade	1		
13	C00212	4	M4X8	Vite - Screw	100		
14	50_A0013_00	4		- Adhesive	1		
15	50_D0045_00	1		Maniglia - Lifting handle	1		
16	50_D0045_00	1		Maniglia - Lifting handle	1		
17	50_D0026_00	2		Paraurti - Bumper	1		
18	050Z04800A	4		Ø 176 - Copertone - Tire	1		
19	050Z05000A	2		Denti ruota interni - Internal wheel teeth	1		
19	050Z05100A	2		Denti ruota esterni - External wheel teeth	1		

50\_D0026\_00

Paraurti - Bumper

**Pulire la superficie ed incollare con Loctite 401**

**Clean the surface and glue with Loctite 401**

Tav.  
Tab.  
Taf.

03

0

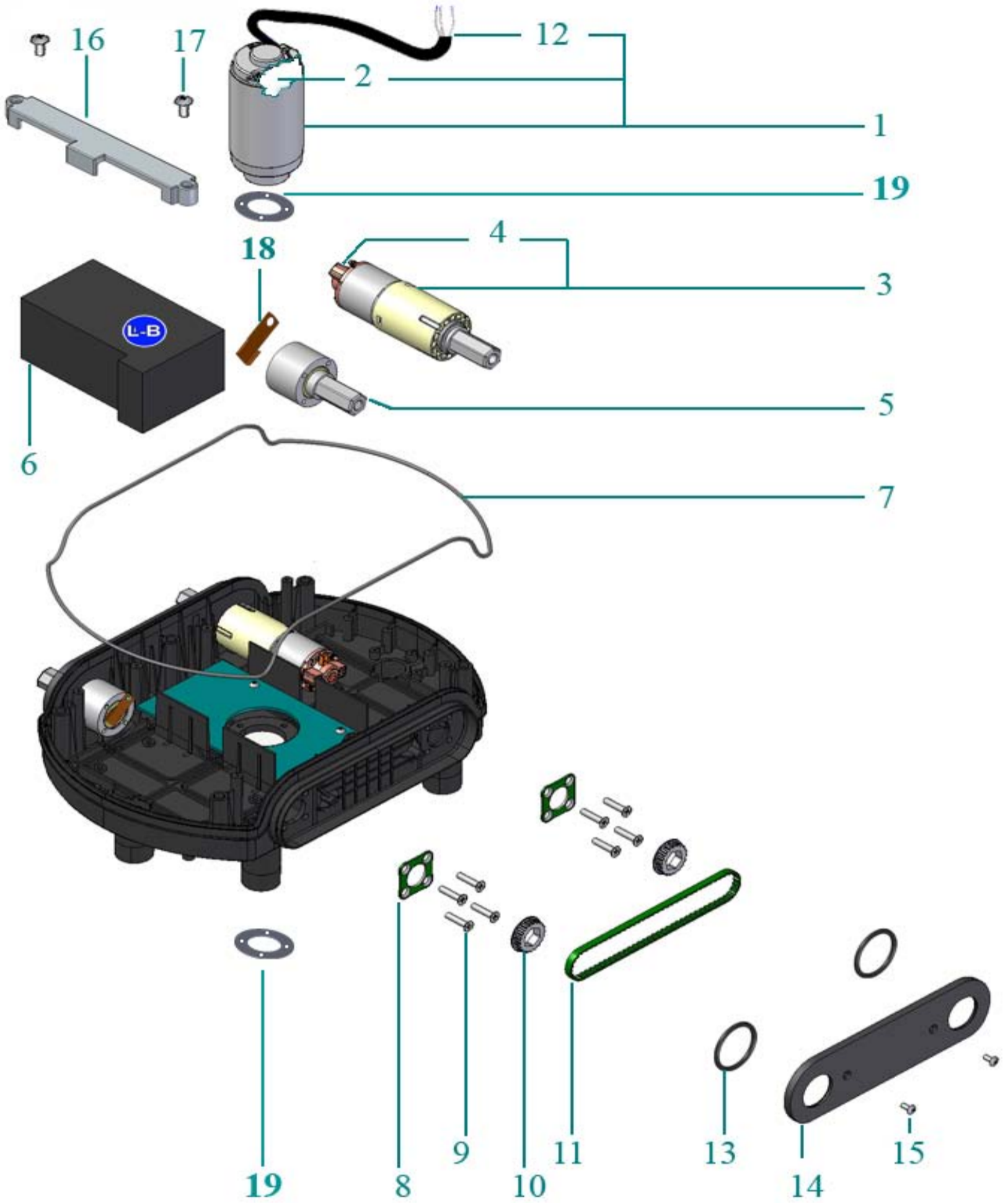

Tav. **03**  
 Tab. **0**  
 Taf.

Rif.	Code	Qty. Part.	Sigla	(IT) Descrizione * (GB) Description	Qty. Price
1	CS_C0009/F	1	24V-25-3000	Motore di Taglio - Cutting Motor	1
2	CS_C0121_01	1		(FS) - Kit Spazzole e Portaspazzole - Brush & Brush housing	1
3	50_A0005_00	2		(IMS) - Motoriduttore - Motor Reducer	1
4	300_C0300	4	10x5x5	(IMS) - Spazzola - Brush	1
5	50_A0002_00	2		(EU) - Perno Ruota Libero - Free wheel pin	1
6	CS_C0106/1	1	Lithium (25.2V 6.9A)	(Type B) - Batteria - Battery	1
6	CS_C0106/2	1	Lithium (25.2V 6.9A)	(Type A) - Batteria - Battery	1
7	50_C0009_00	1		Guarnizione - Gasket	1
8	50_D0003_00	4		Piastra - Plate	1
9	C00205	16	M5X22	Vite - Screw	100
10	50_D0004_01	4	(2009) Model	Puleggia - Pulley	1
10	050Z06300A	4	(2010) Model	Puleggia - Pulley (Use only with C00536)	1
11	50_C0001_00	2	(2009) Model	Cinghia - Belt	1
11	C00536	2	(2010) Model	Cinghia - Belt (Use only with 050Z06300A)	1
12	CS_D0122_01	1		(FS) - Encoder Lama - Blade encoder	1
13	50_C0002_00	4		Oring - Oring	10
14	50_D0027_00	2		Carter - Carter	1
15	C00208	4	M4X25	Vite - Screw	100
16	50_D0041_00	1		Fissaggio Batteria - Battery Clamp	1
17	C00210	2	M4X12	Vite - Screw	100
18	050Z04400A	2		Molla - Spring	1
19	050Z06700A	2		Guarnizione - Gasket	10

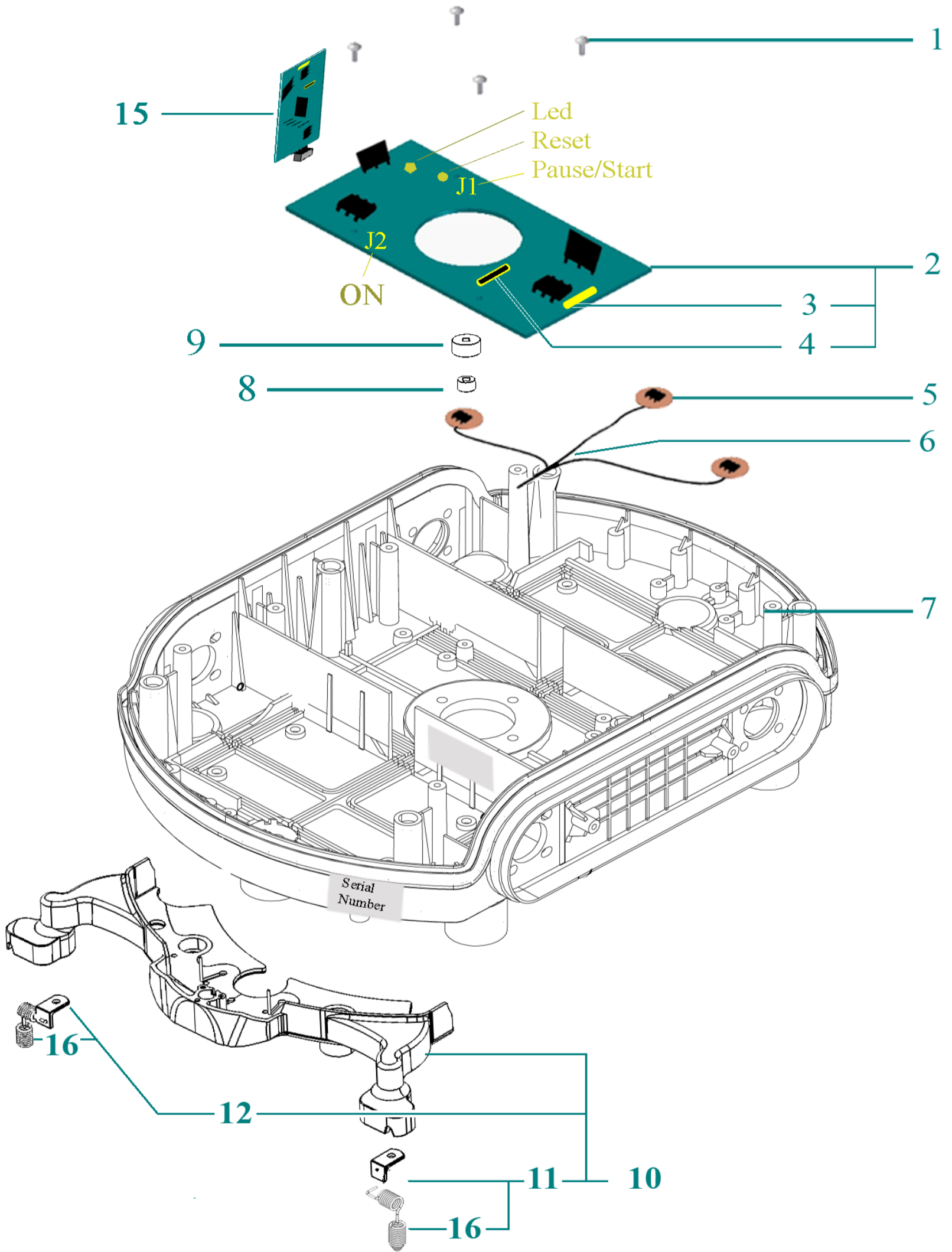



Tav.	04	0	
Tab.			
Taf.			

Rif.	Code	Qty. Part.	Sigla	(IT) Descrizione * (GB) Description	Qty. Price
1	C00214	4	M3X10	Vite - Screw	100
2	50_SMEU_01	1		Scheda Madre - Mother Board	1
3	A210541	1	32V 20A	Kit Fusibili - Fuse Kit	10
4	A210540	1	32V 1A	Kit Fusibili - Fuse Kit	10
5	50_E0007_00	6		Sensore Erba - Grass Sensor	1
6	50_E0006_00	2		Cavo - Wire	1
7	50_D0021_00	1		Scocca - Body	1
8	50_D0048_00	6	D16 Sp10	Guarnizione - Gasket	20
9	50_D0047_00	6	D26 Sp13	Guarnizione - Gasket	20
10	K-050Z05400A	1	Kit-Upgrade	Kit Sensore baratro - Curb drop-off Sensor Kit	1
10	050Z05400A	2		Sensore baratro - Curb drop-off Sensor	1
11	050Z08600A	2		Sensore - Sensor	1
12	050Z08500A	2		Sensore - Sensor	1
13	50_E0004_00	1		Cavo Batteria - Battery Wire	1
14	50_E0010_00	2		Cavo Motore Ruota - Wheel Motor Wire	1
15	CS_E0027-50	1		Ricevitore Bluetooth - Bluetooth Receiver	1
16	K-050Z08200A	1		Kit 4 Molle - Kit of 4 springs	1
16	K2-050Z08200A	1		Kit 20 Molle - Kit of 20 springs	1



**K-050Z05400A : Kit Sensore baratro installabile solo nelle schede madri Ver- 4.0 o successive**  
**K-050Z05400A : Please install the curb drop-off sensor kit only on the "Ver- 4.0" mother board or later**